

FURNITURE LEGEND	
A	(A1-A10) INSTRUMENT STORAGE CABINET (REFER TO INSTRUMENT QUANTITIES BELOW)
B1	MUSICIAN CHAIR
C1	MUSIC STAND
D1	CONDUCTOR'S MOBILE STATION
E1	UNIFORM STORAGE RACK

INSTRUMENT QUANTITIES	
QTY.	INSTRUMENT
20	FLUTE
4	OBOE
30	B-FLAT CLARINET
8	1-PC BASS CLARINET
2	CONTRABASS CLARINET
4	BASSOON
20	ALTO SAXOPHONE
8	TENOR SAXOPHONE
4	BARITONE SAXOPHONE
35	TRUMPET
12	FRENCH HORN
20	TROMBONE
2	BASS TROMBONE
12	EUPHONIUM
12	TUBA (UPRIGHT BELL)
16	MARCHING MELLOPHONE
16	MARCHING BARITONE
2	ELECTRIC GUITAR
2	BASS GUITAR
(PERCUSSION)	
8	PARADE DRUM 12x15
2	BASS DRUM 14x22
2	BASS DRUM 14x24
2	BASS DRUM 14x28
2	BASS DRUM 16x30
2	BASS DRUM 16x32
4	CONCERT BASS DRUM 16x36
1	TAMBOURINE
1	ORCHESTRA BELLS
1	CHIMES
3	MARIMBA UNDER 58"
3	VIBES UNDER 58"
2	XYLOPHONE UNDER 58"
4	MARCHING QUINETS
16	SOUSAPHONE

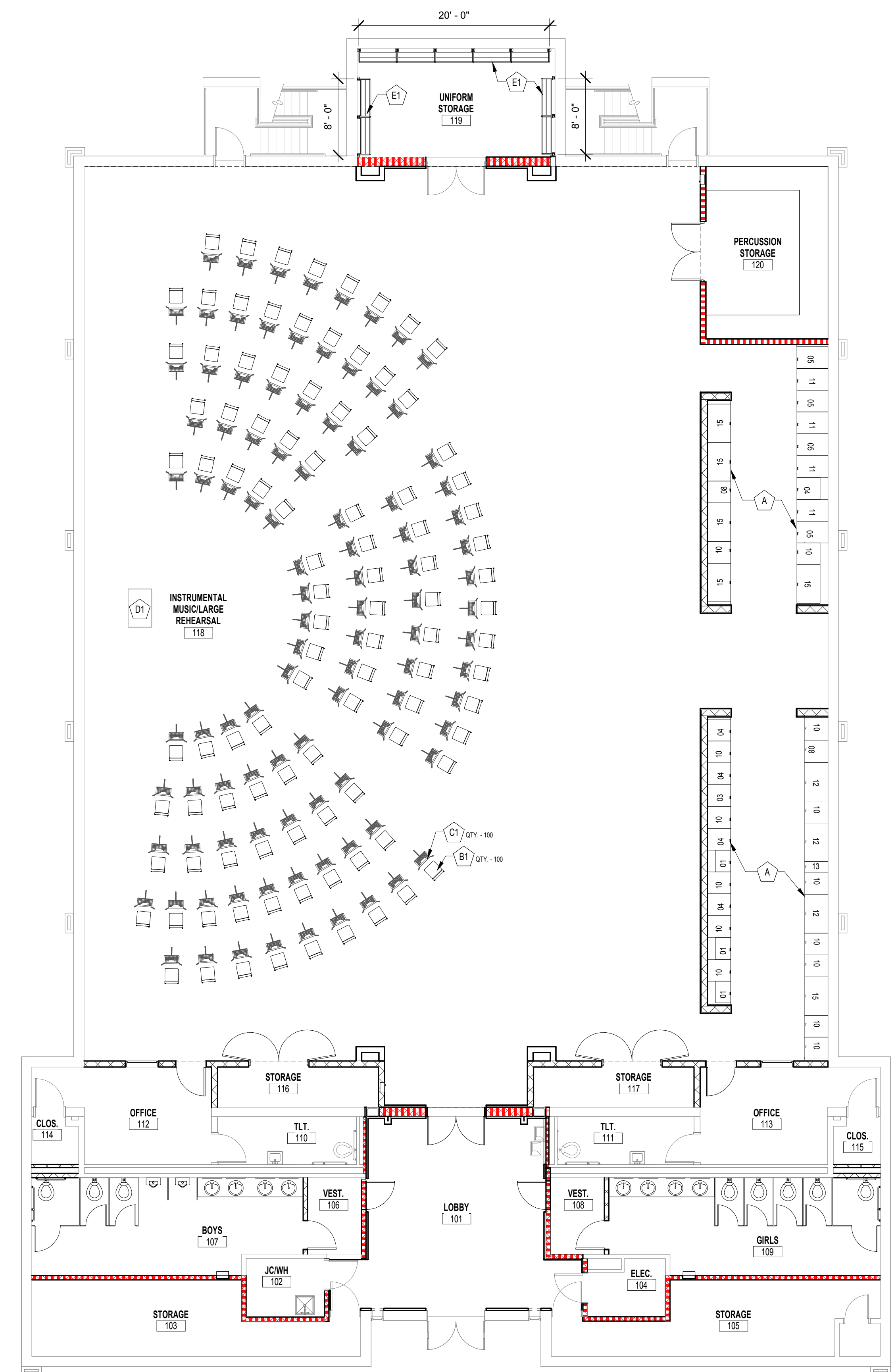

1 FURNITURE PLAN
1/8" = 1'-0"

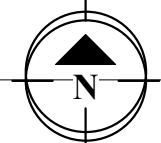

BARTLETT CITY SCHOOLS
BAND BUILDING RENOVATIONS
5688 Woodlawn St. Bartlett, TN 38134



REVISIONS		
Revision Date	Rev. #	Revision Description

PROJECT NUMBER	340317
DATE OF ORIGINAL ISSUE	APRIL 28, 2017
SHEET NUMBER	A9.1

FF&E SPECIFICATIONS
Bartlett High School Band Room
5688 Woodlawn St.
Bartlett, TN 38134

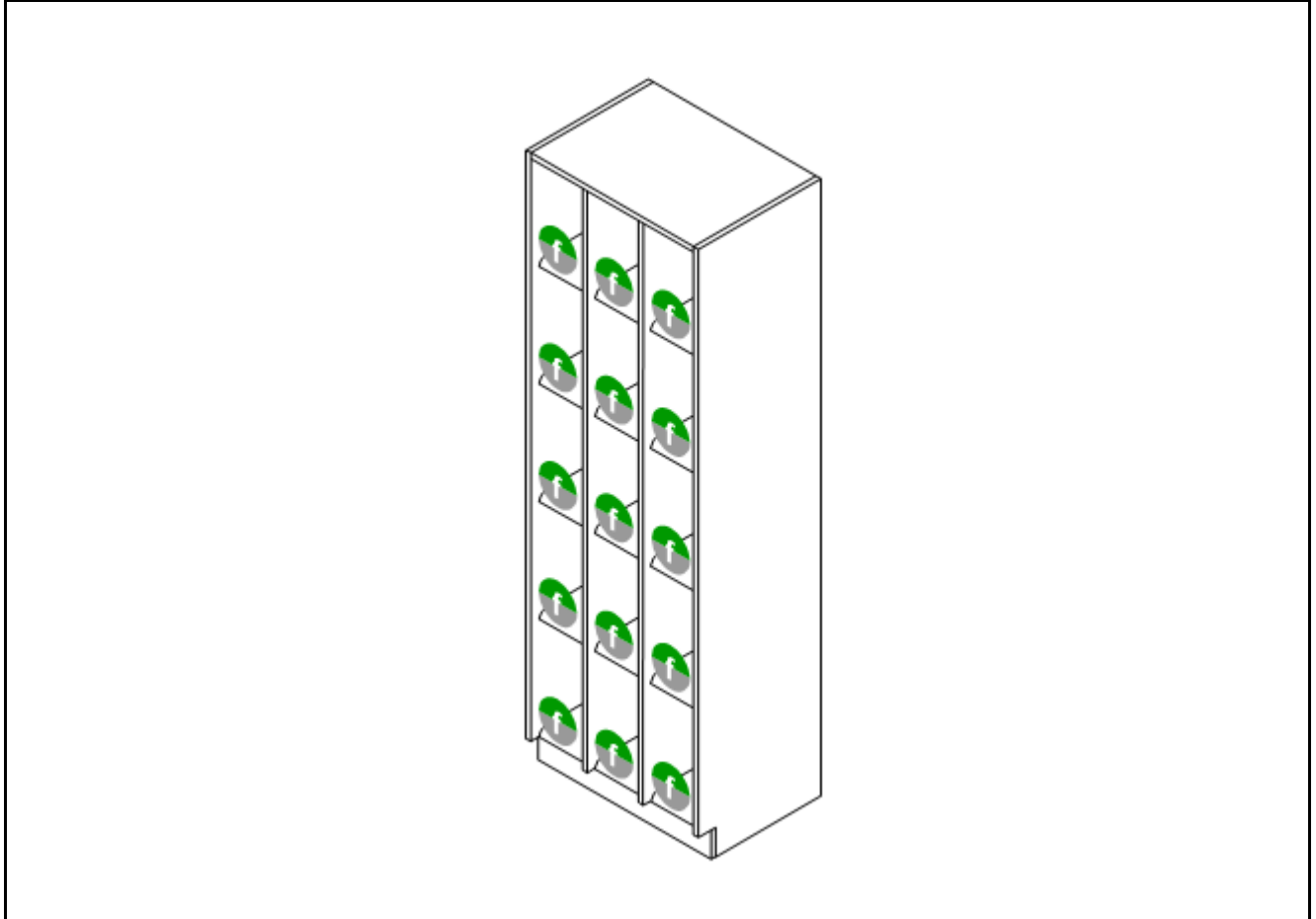

Tag: A1-1

Description: Instrument Cabinet

Manufacturer: Wenger

Manufacturer's Description: UltraStor 1 w/ Straight Grille Doors

Finish: Wenger Maple

Quantity: 1

Instruments: 15 Flutes

FF&E SPECIFICATIONS
Bartlett High School Band Room
5688 Woodlawn St.
Bartlett, TN 38134

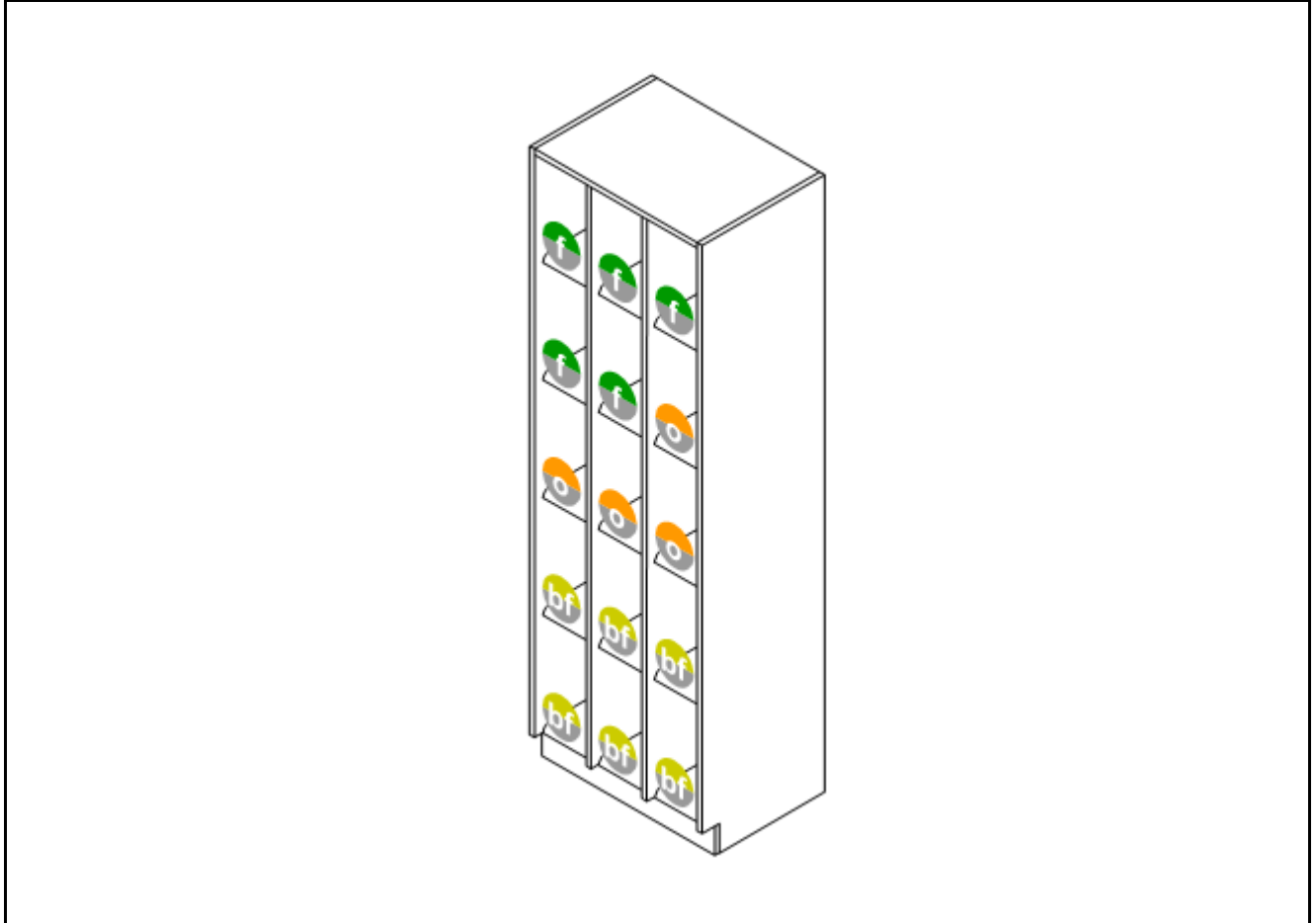

Tag: A1-2

Description: Instrument Cabinet

Manufacturer: Wenger

Manufacturer's Description: UltraStor 1 w/ Straight Grille Doors

Finish: Wenger Maple

Quantity: 1

Instruments: 5 Flutes, 4 Oboes, 6 B-Flat Clarinets

FF&E SPECIFICATIONS
Bartlett High School Band Room
5688 Woodlawn St.
Bartlett, TN 38134

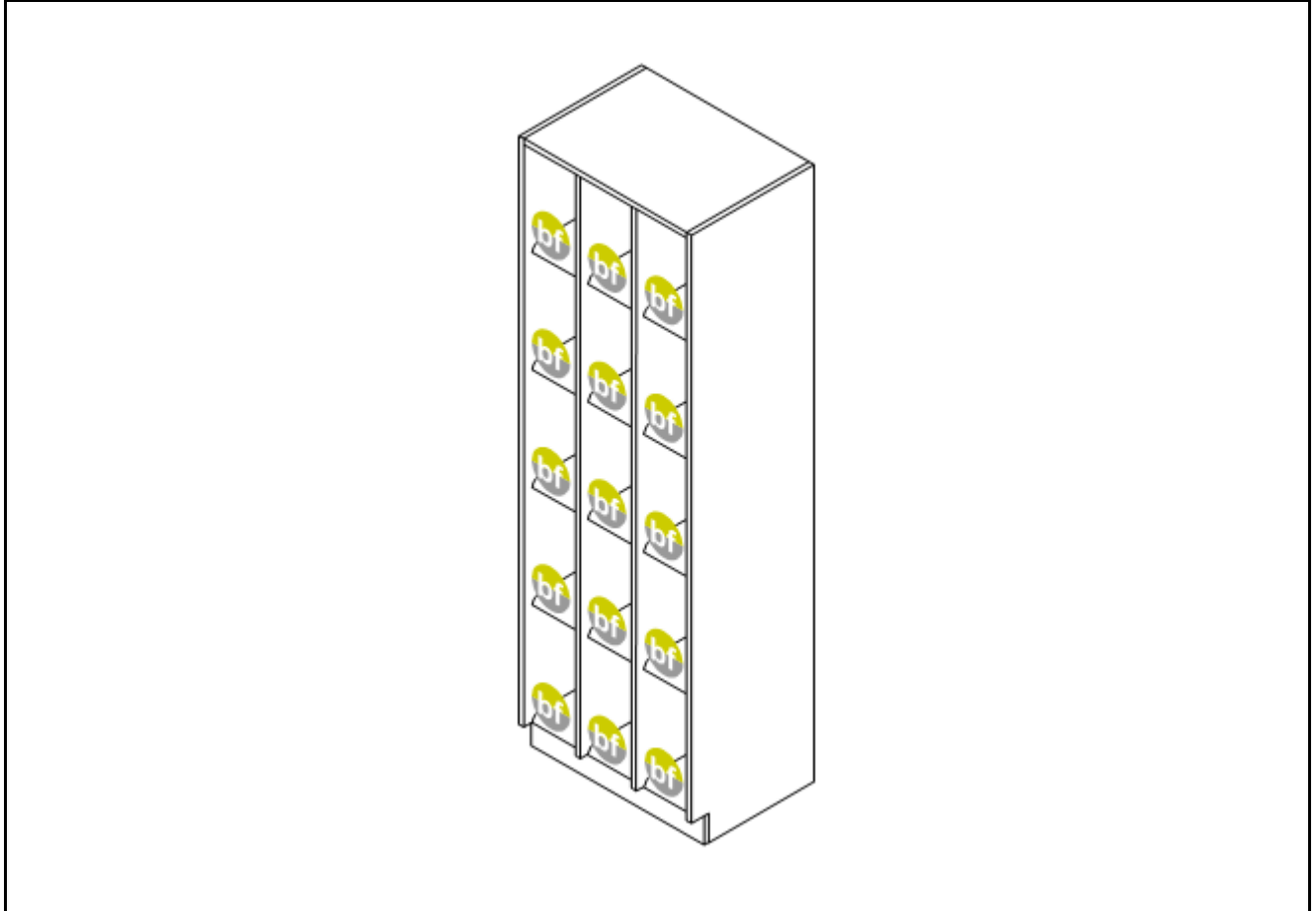

Tag: A1-3

Description: Instrument Cabinet

Manufacturer: Wenger

Manufacturer's Description: UltraStor 1 w/ Straight Grille Doors

Finish: Wenger Maple

Quantity: 1

Instruments: 15 B-Flat Clarinets

FF&E SPECIFICATIONS
Bartlett High School Band Room
5688 Woodlawn St.
Bartlett, TN 38134

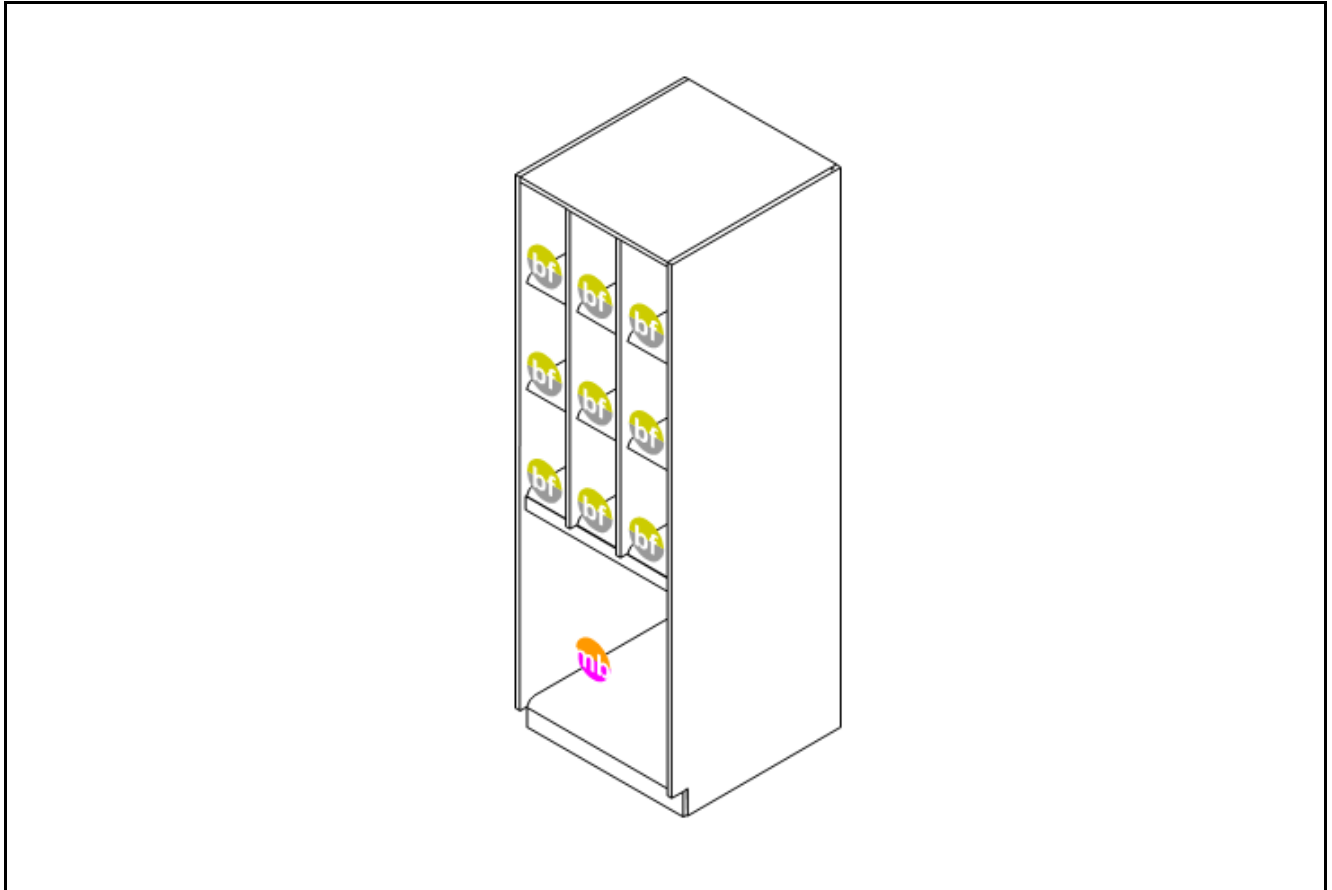

Tag: A2

Description: Instrument Cabinet

Manufacturer: Wenger

Manufacturer's Description: UltraStor 3 w/ Straight Grille Doors

Finish: Wenger Maple

Quantity: 1

Instruments: 9 B-Flat Clarinets, 1 Marching Baritone

FF&E SPECIFICATIONS
Bartlett High School Band Room
5688 Woodlawn St.
Bartlett, TN 38134

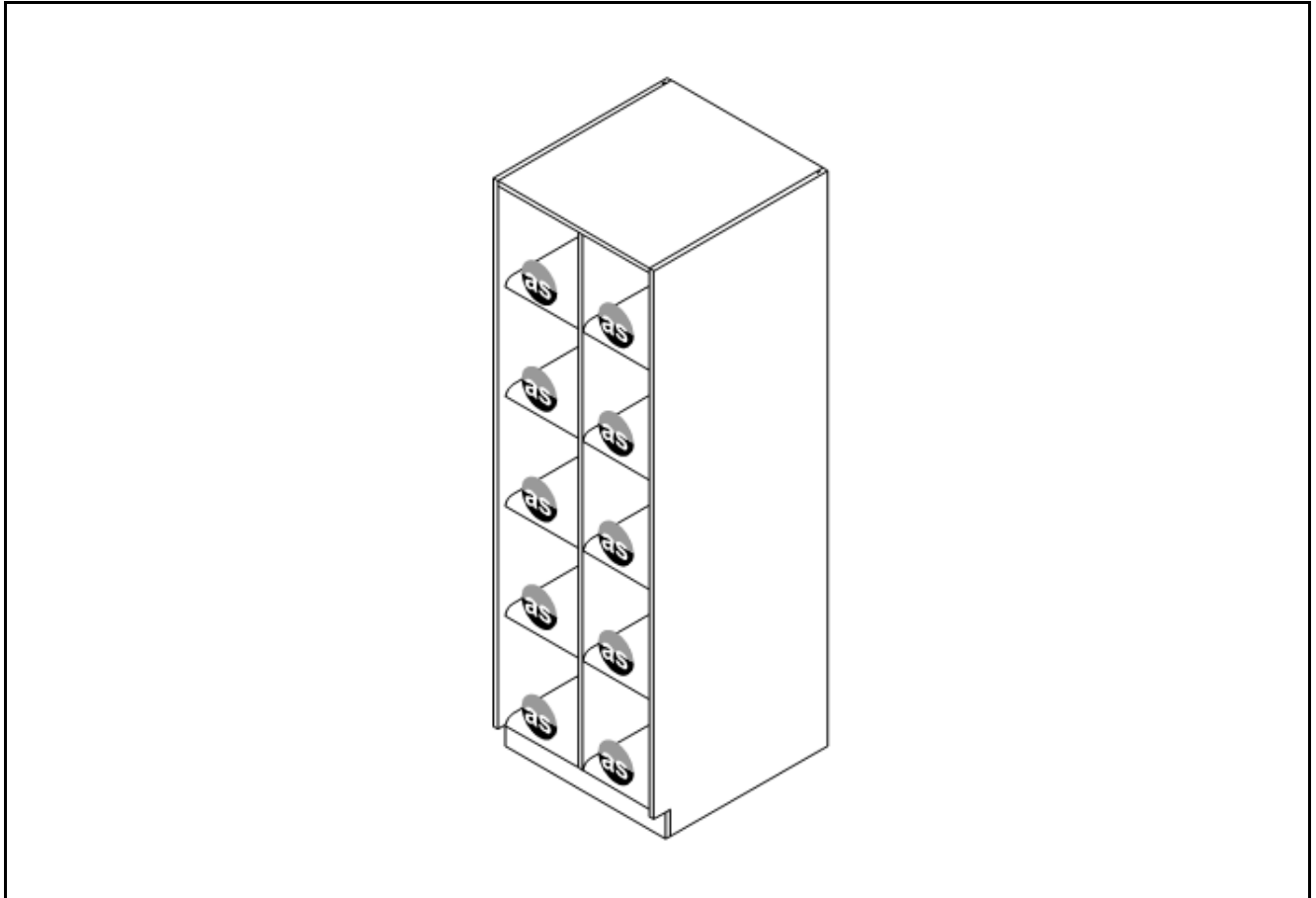

Tag: A3-1

Description: Instrument Cabinet

Manufacturer: Wenger

Manufacturer's Description: UltraStor 4 w/ Straight Grille Doors

Finish: Wenger Maple

Quantity: 1

Instruments: 10 Alto Saxophones

FF&E SPECIFICATIONS
Bartlett High School Band Room
5688 Woodlawn St.
Bartlett, TN 38134

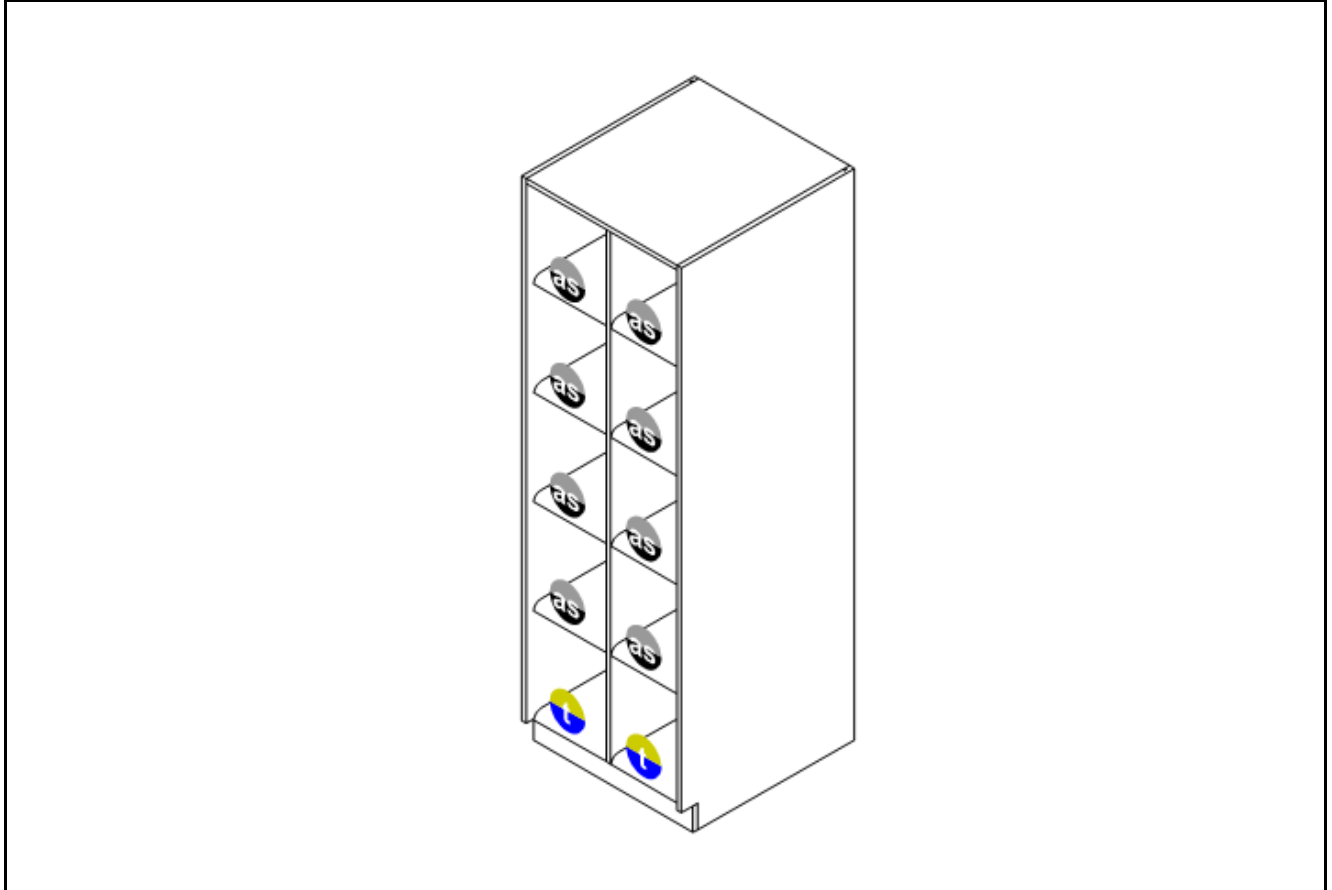

Tag: A3-2

Description: Instrument Cabinet

Manufacturer: Wenger

Manufacturer's Description: UltraStor 4 w/ Straight Grille Doors

Finish: Wenger Maple

Quantity: 1

Instruments: 8 Alto Saxophones, 2 Trumpets

FF&E SPECIFICATIONS
Bartlett High School Band Room
5688 Woodlawn St.
Bartlett, TN 38134

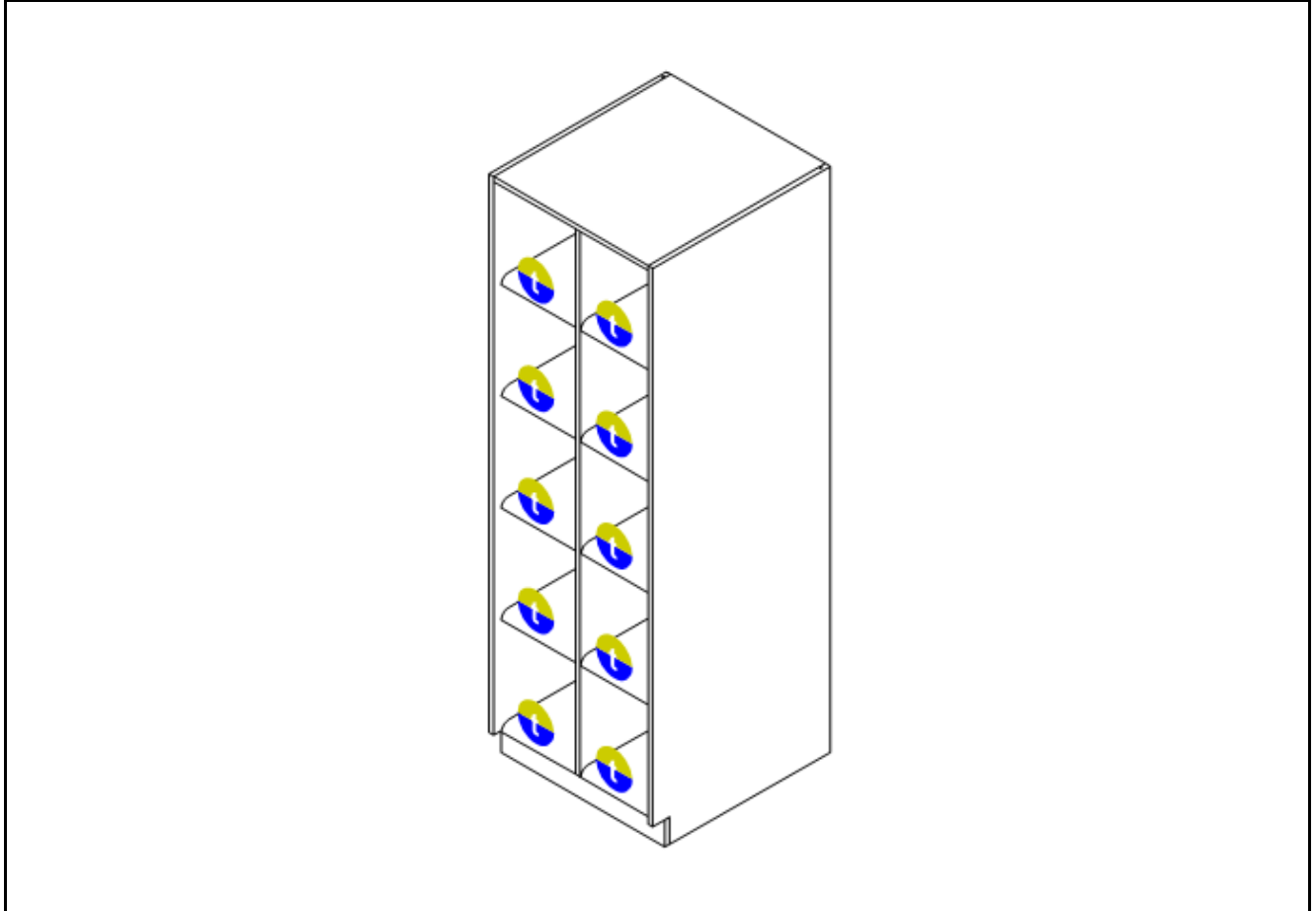

Tag: A3-3

Description: Instrument Cabinet

Manufacturer: Wenger

Manufacturer's Description: UltraStor 4 w/ Straight Grille Doors

Finish: Wenger Maple

Quantity: 3

Instruments: 10 Trumpets

FF&E SPECIFICATIONS
Bartlett High School Band Room
5688 Woodlawn St.
Bartlett, TN 38134

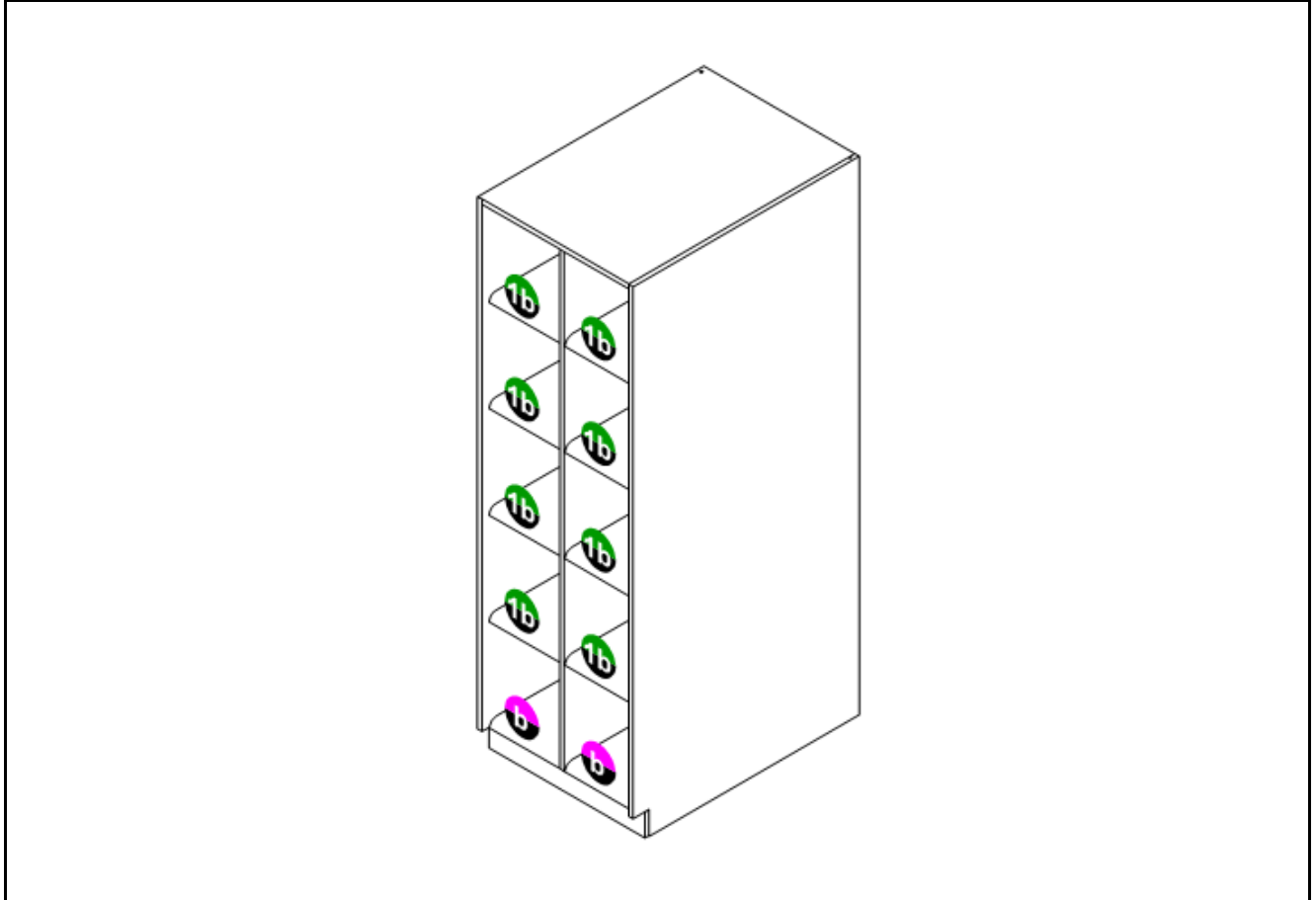

Tag: A4-1

Description: Instrument Cabinet

Manufacturer: Wenger

Manufacturer's Description: UltraStor 5 w/ Straight Grille Doors

Finish: Wenger Maple

Quantity: 1

Instruments: 8 Bass Clarinets, 2 Bassoons

FF&E SPECIFICATIONS
Bartlett High School Band Room
5688 Woodlawn St.
Bartlett, TN 38134

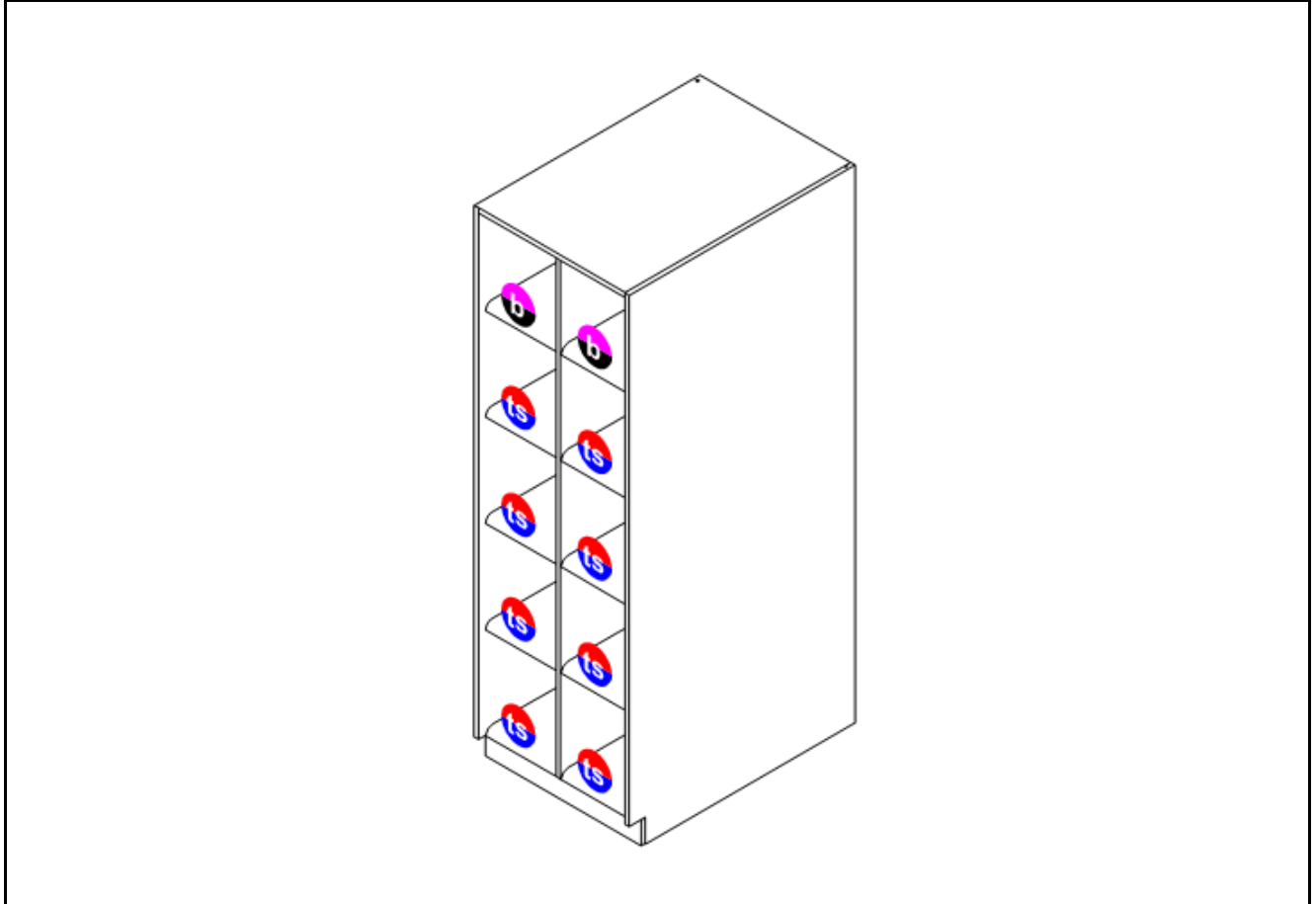

Tag: A4-2

Description: Instrument Cabinet

Manufacturer: Wenger

Manufacturer's Description: UltraStor 5 w/ Straight Grille Doors

Finish: Wenger Maple

Quantity: 1

Instruments: 2 Bassoons, 8 Tenor Saxophones



FF&E SPECIFICATIONS
Bartlett High School Band Room
5688 Woodlawn St.
Bartlett, TN 38134

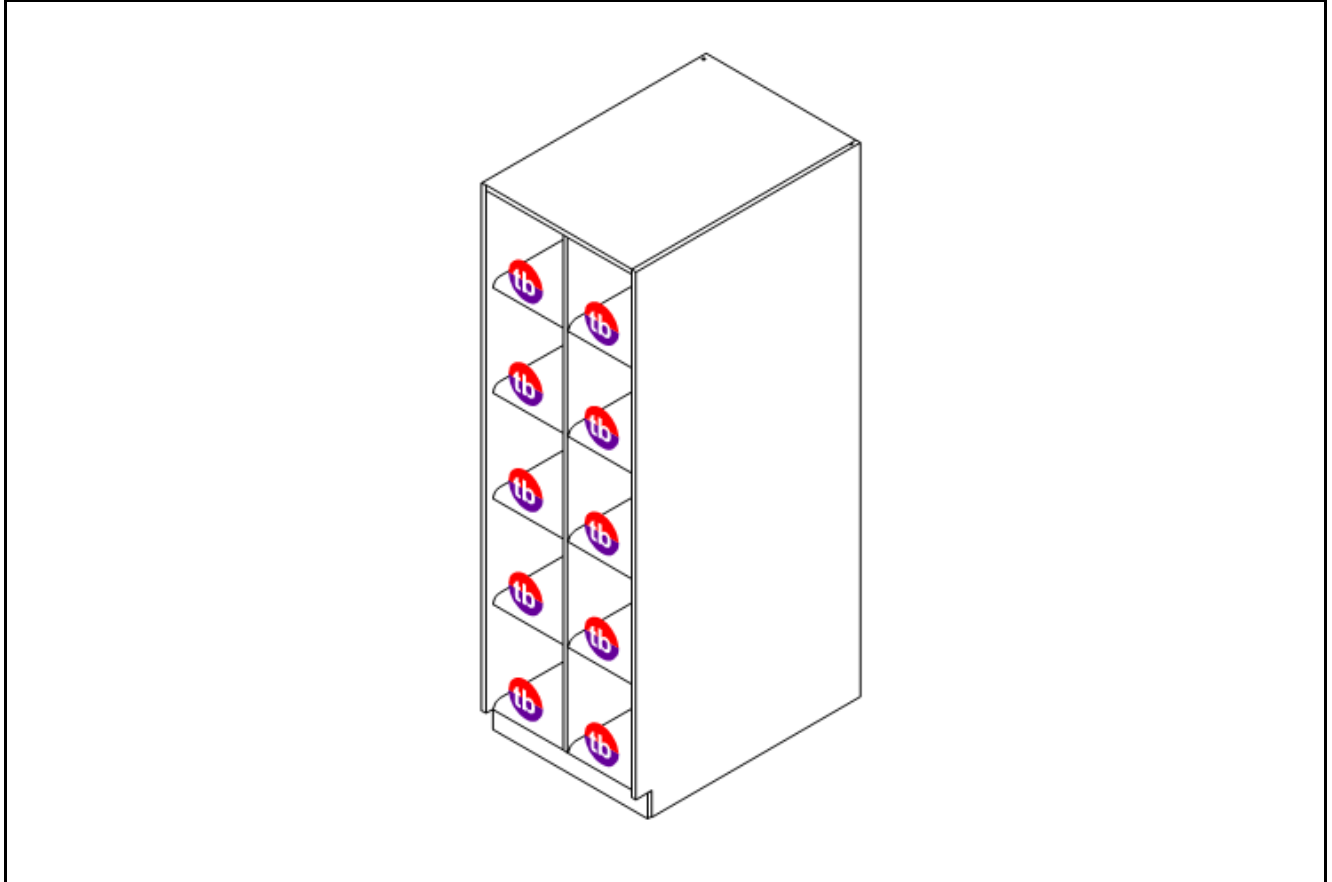

Tag: A4-3

Description: Instrument Cabinet

Manufacturer: Wenger

Manufacturer's Description: UltraStor 5 w/ Straight Grille Doors

Finish: Wenger Maple

Quantity: 2

Instruments: 10 Trombones



FF&E SPECIFICATIONS
Bartlett High School Band Room
5688 Woodlawn St.
Bartlett, TN 38134

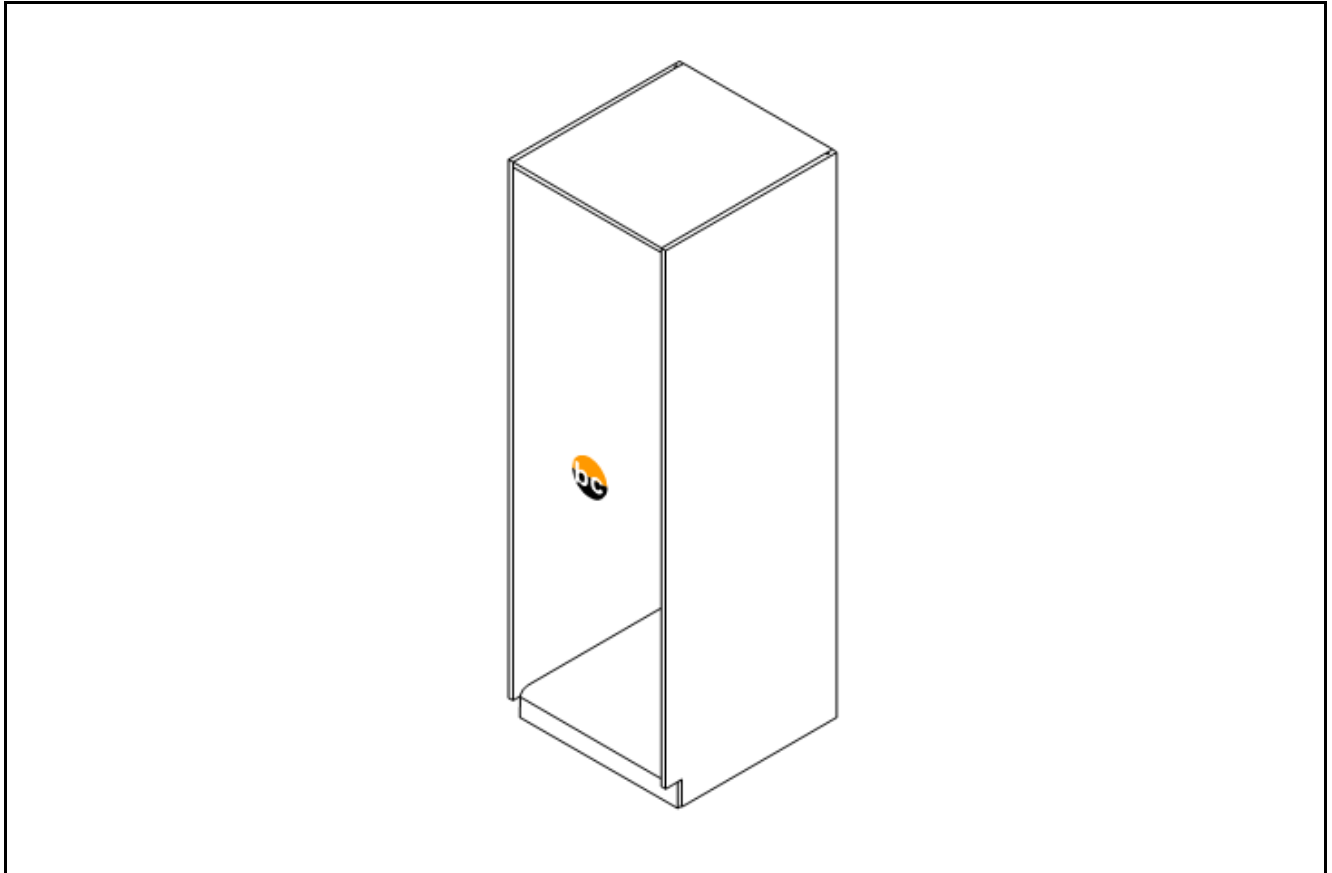

Tag: A5

Description: Instrument Cabinet

Manufacturer: Wenger

Manufacturer's Description: UltraStor 8 w/ Straight Grille Doors

Finish: Wenger Maple

Quantity: 2

Instruments: 1 Contrabass Clarinet



FF&E SPECIFICATIONS
Bartlett High School Band Room
5688 Woodlawn St.
Bartlett, TN 38134

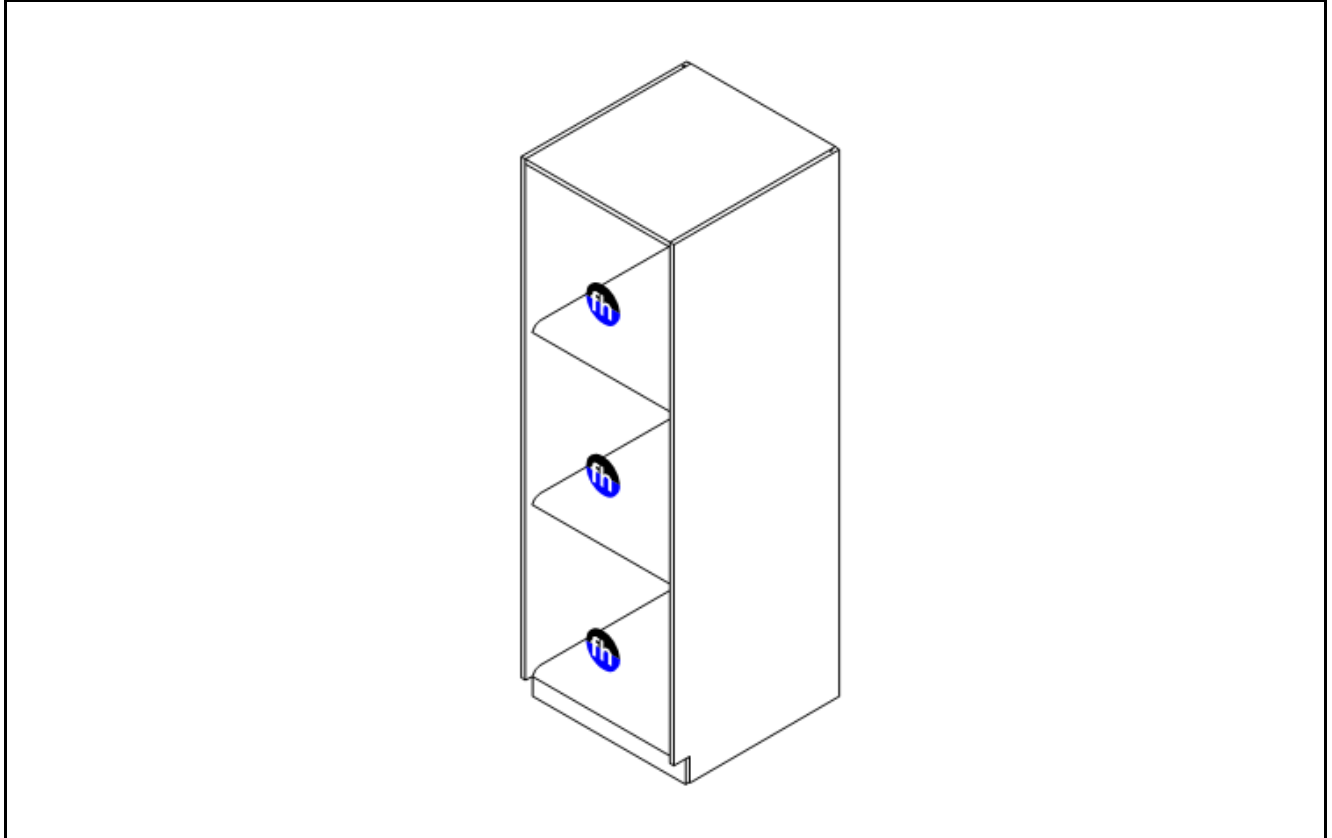

Tag: A6-1

Description: Instrument Cabinet

Manufacturer: Wenger

Manufacturer's Description: UltraStor 10 w/ Straight Grille Doors

Finish: Wenger Maple

Quantity: 3

Instruments: 3 French Horns



FF&E SPECIFICATIONS
Bartlett High School Band Room
5688 Woodlawn St.
Bartlett, TN 38134

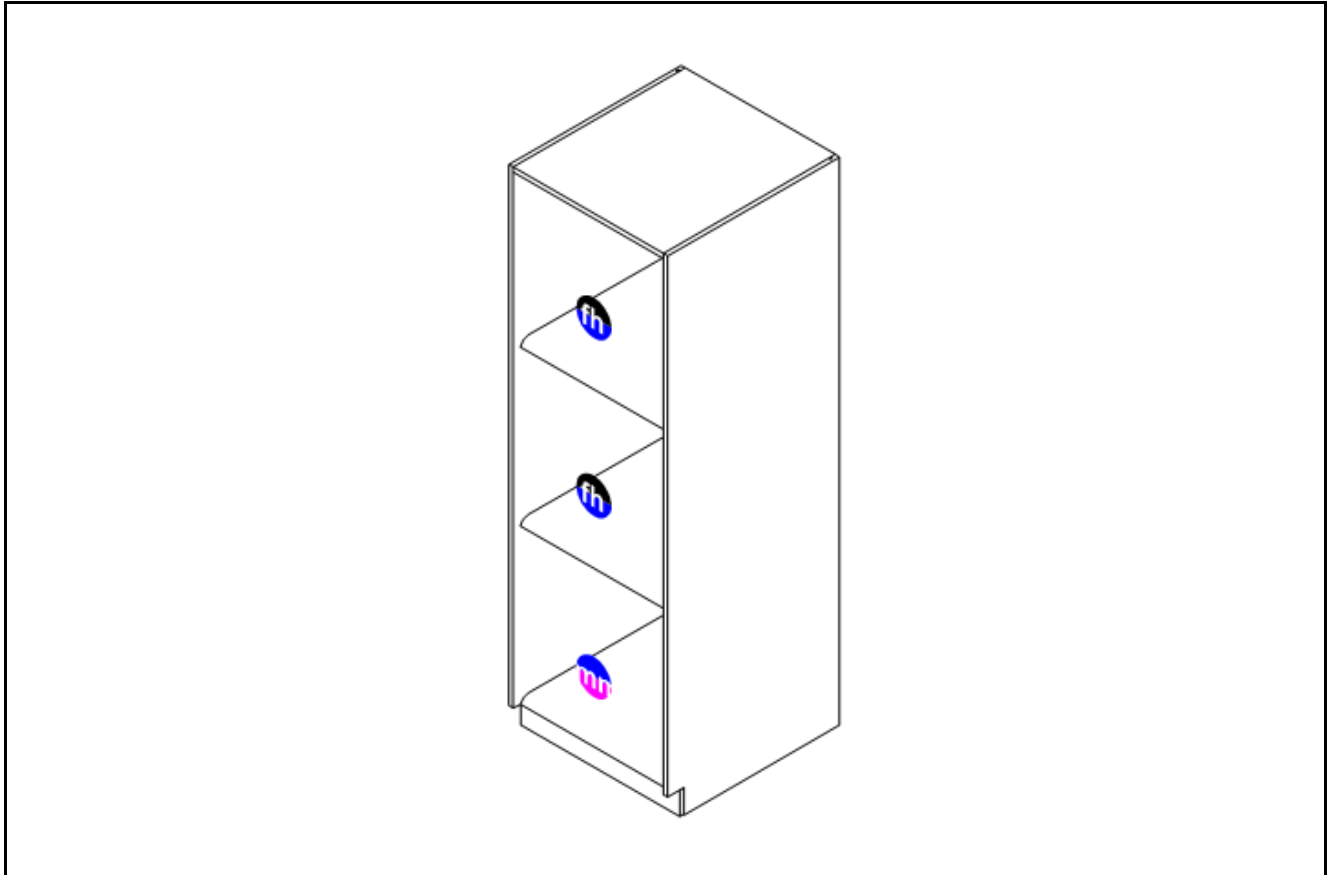

Tag: A6-2

Description: Instrument Cabinet

Manufacturer: Wenger

Manufacturer's Description: UltraStor 10 w/ Straight Grille Doors

Finish: Wenger Maple

Quantity: 1

Instruments: 2 French Horns, 1 Marching Mellophone

FF&E SPECIFICATIONS

Bartlett High School Band Room

5688 Woodlawn St.
Bartlett, TN 38134

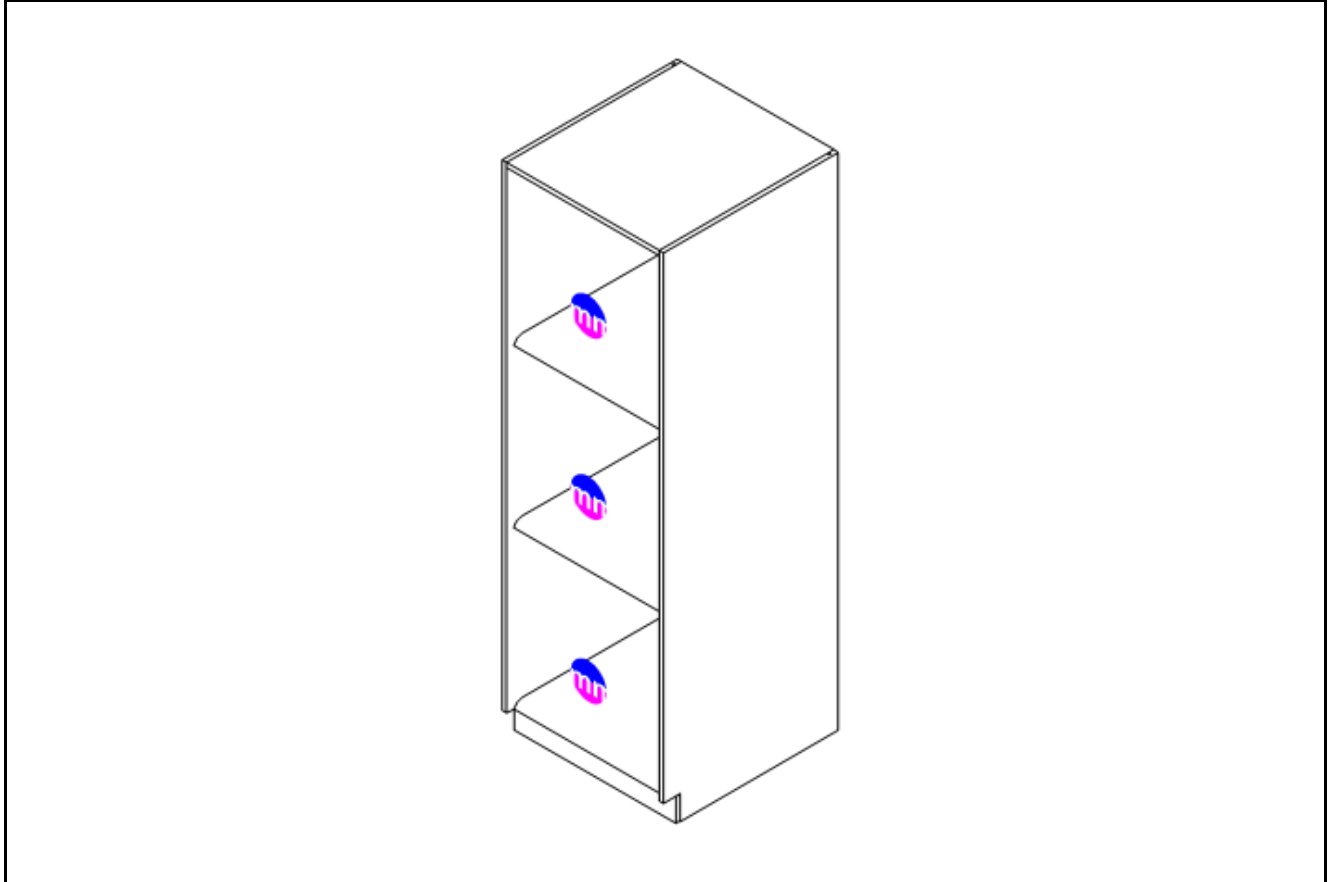

Tag: A6-3

Description: Instrument Cabinet

Manufacturer: Wenger

Manufacturer's Description: UltraStor 10 w/ Straight Grille Doors

Finish: Wenger Maple

Quantity: 5

Instruments: 3 Marching Mellophones

FF&E SPECIFICATIONS
Bartlett High School Band Room
5688 Woodlawn St.
Bartlett, TN 38134

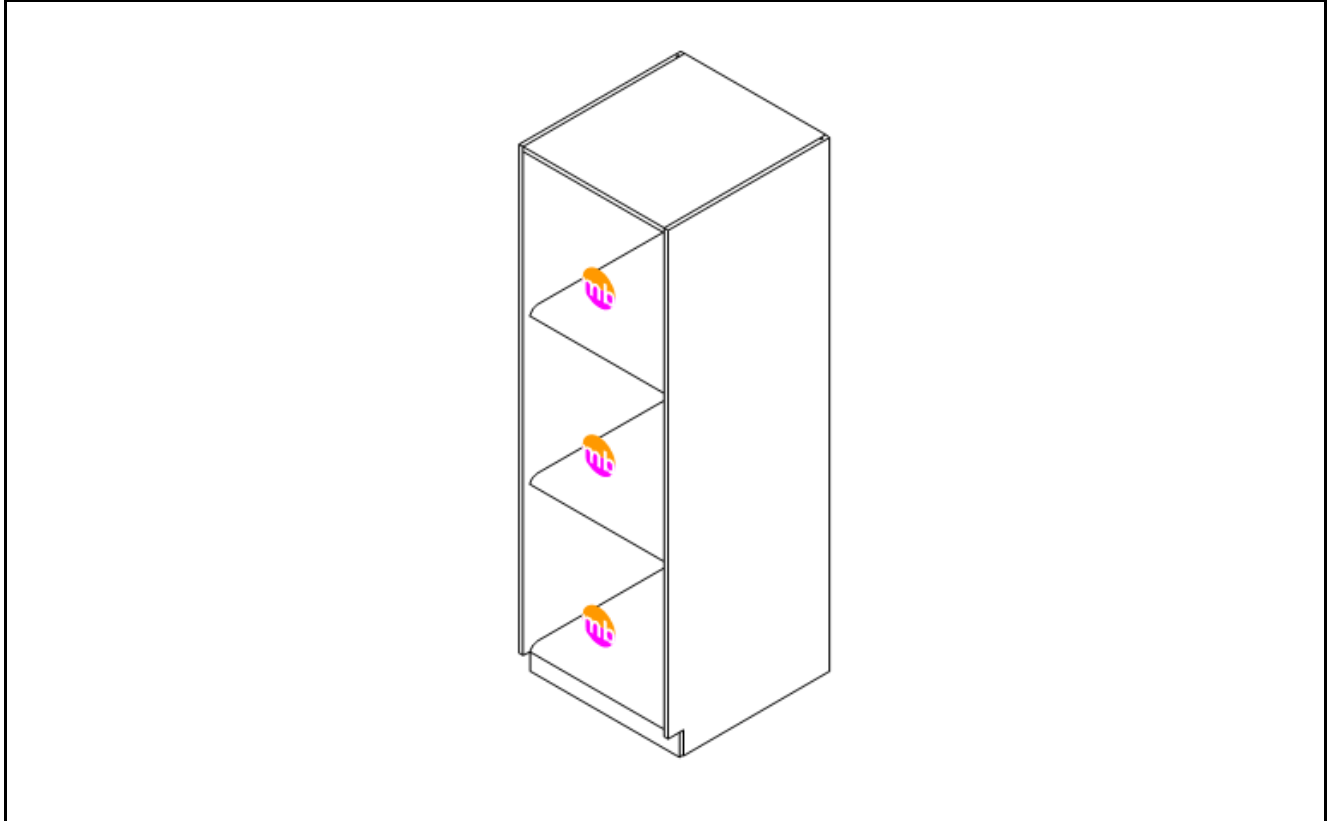

Tag: A6-4

Description: Instrument Cabinet

Manufacturer: Wenger

Manufacturer's Description: UltraStor 10 w/ Straight Grille Doors

Finish: Wenger Maple

Quantity: 5

Instruments: 3 Marching Baritones



FF&E SPECIFICATIONS
Bartlett High School Band Room
5688 Woodlawn St.
Bartlett, TN 38134

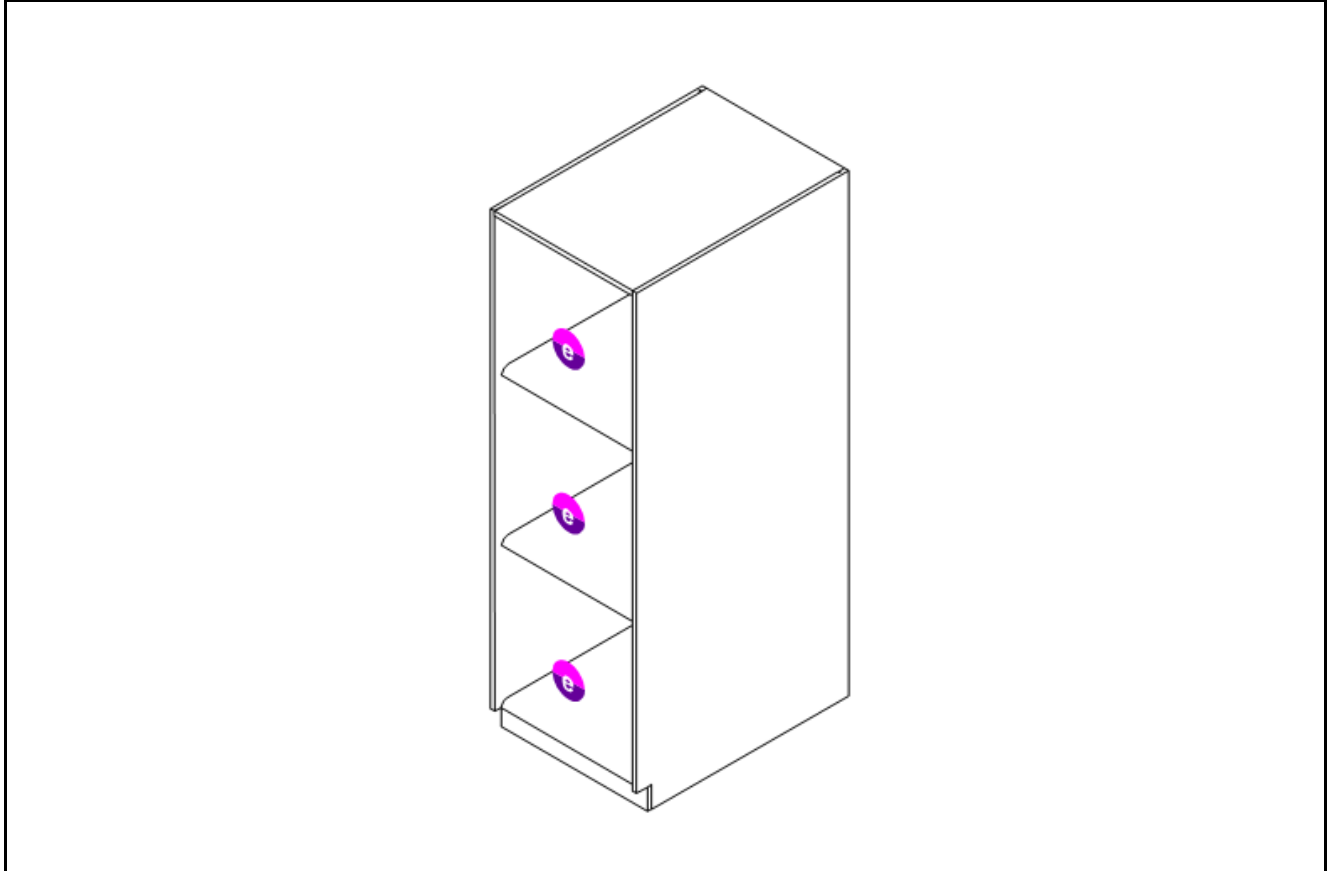

Tag: A7-1

Description: Instrument Cabinet

Manufacturer: Wenger

Manufacturer's Description: UltraStor 11 w/ Straight Grille Doors

Finish: Wenger Maple

Quantity: 3

Instruments: 3 Euphoniums

FF&E SPECIFICATIONS
Bartlett High School Band Room
5688 Woodlawn St.
Bartlett, TN 38134

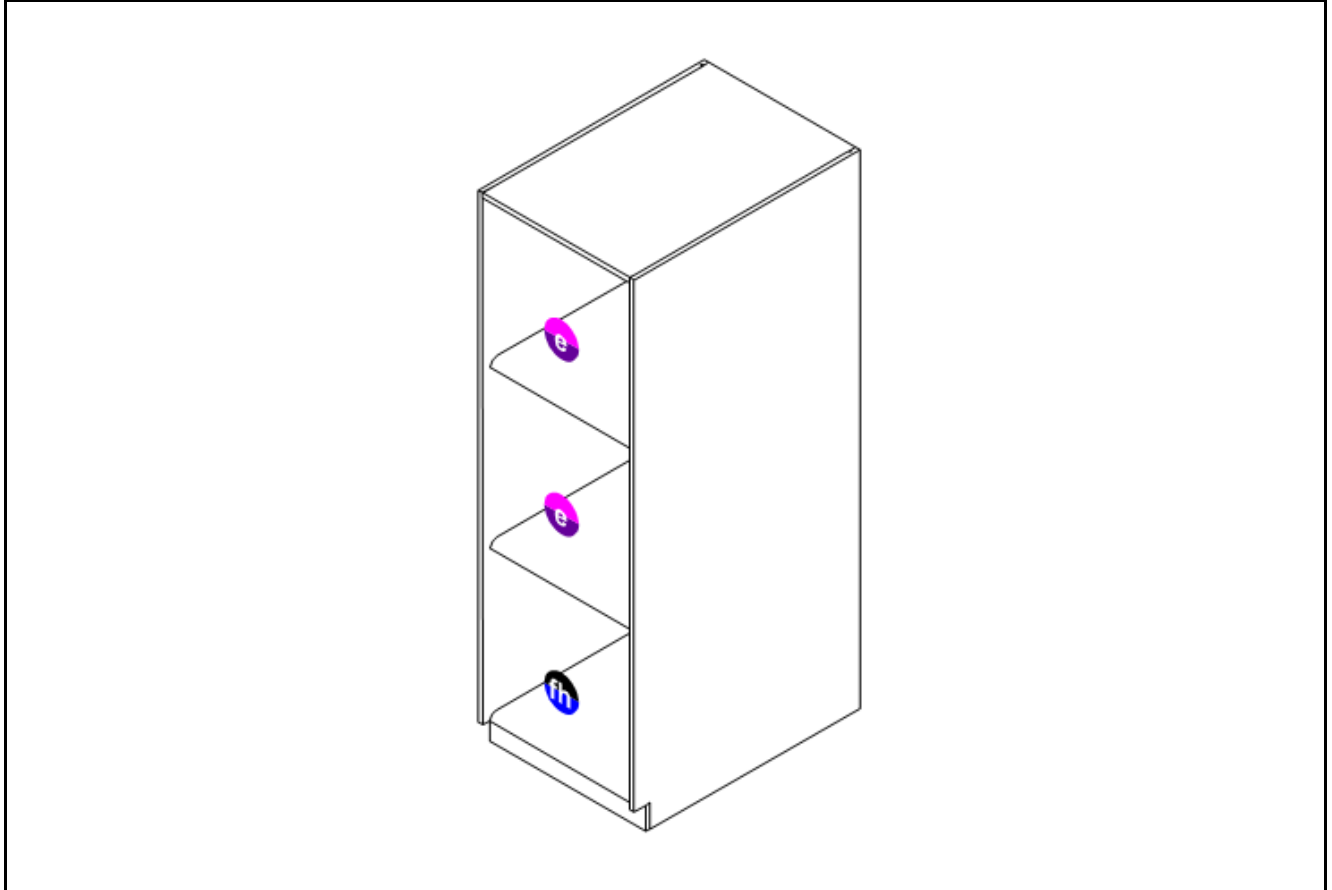

Tag: A7-2

Description: Instrument Cabinet

Manufacturer: Wenger

Manufacturer's Description: UltraStor 11 w/ Straight Grille Doors

Finish: Wenger Maple

Quantity: 1

Instruments: 2 Euphoniums, 1 French Horn

FF&E SPECIFICATIONS
Bartlett High School Band Room
5688 Woodlawn St.
Bartlett, TN 38134

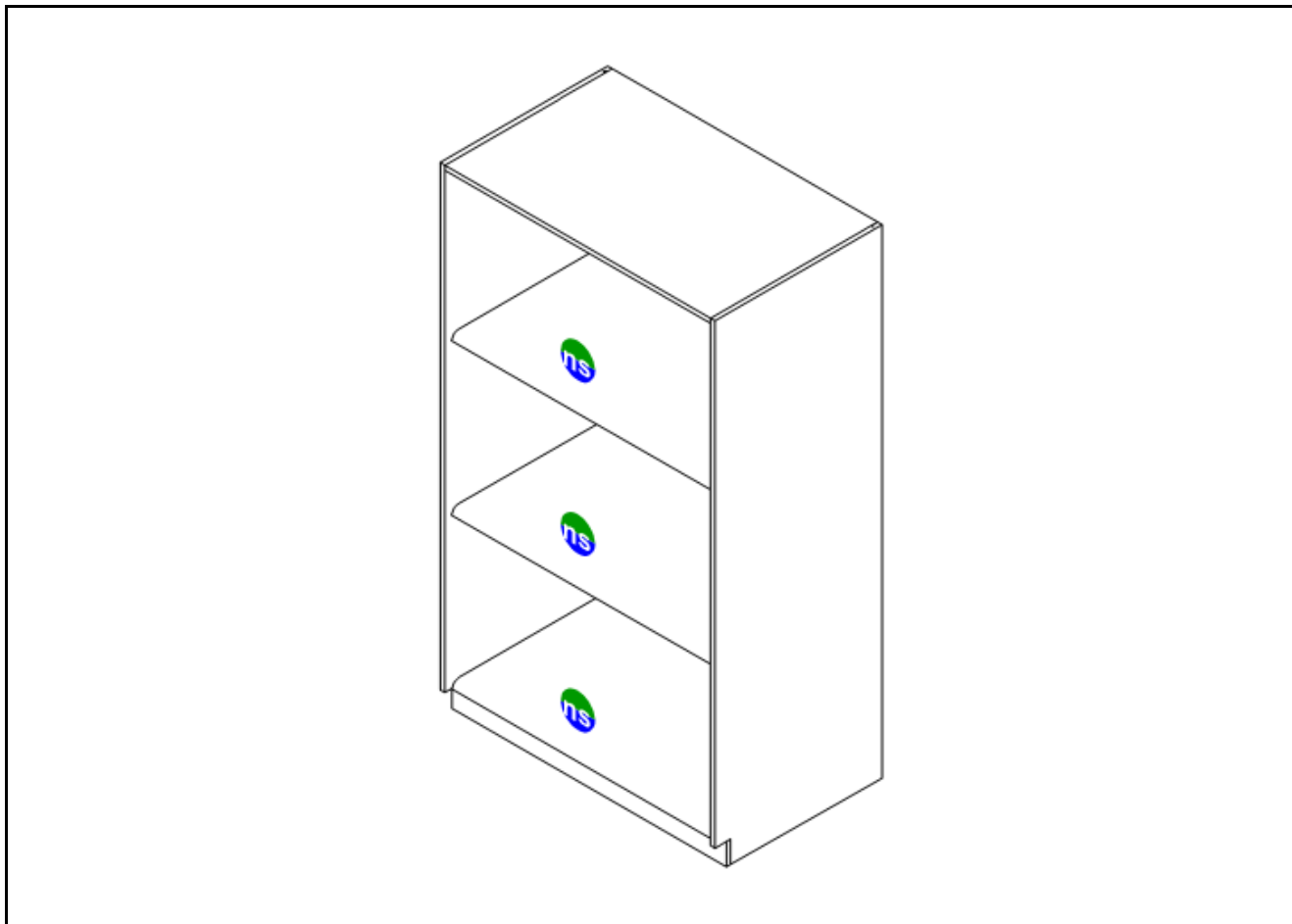

Tag: A8-1

Description: Instrument Cabinet

Manufacturer: Wenger

Manufacturer's Description: UltraStor 12 w/ Straight Grille Doors

Finish: Wenger Maple

Quantity: 1

Instruments: 3 Baritone Saxophones

FF&E SPECIFICATIONS
Bartlett High School Band Room
5688 Woodlawn St.
Bartlett, TN 38134

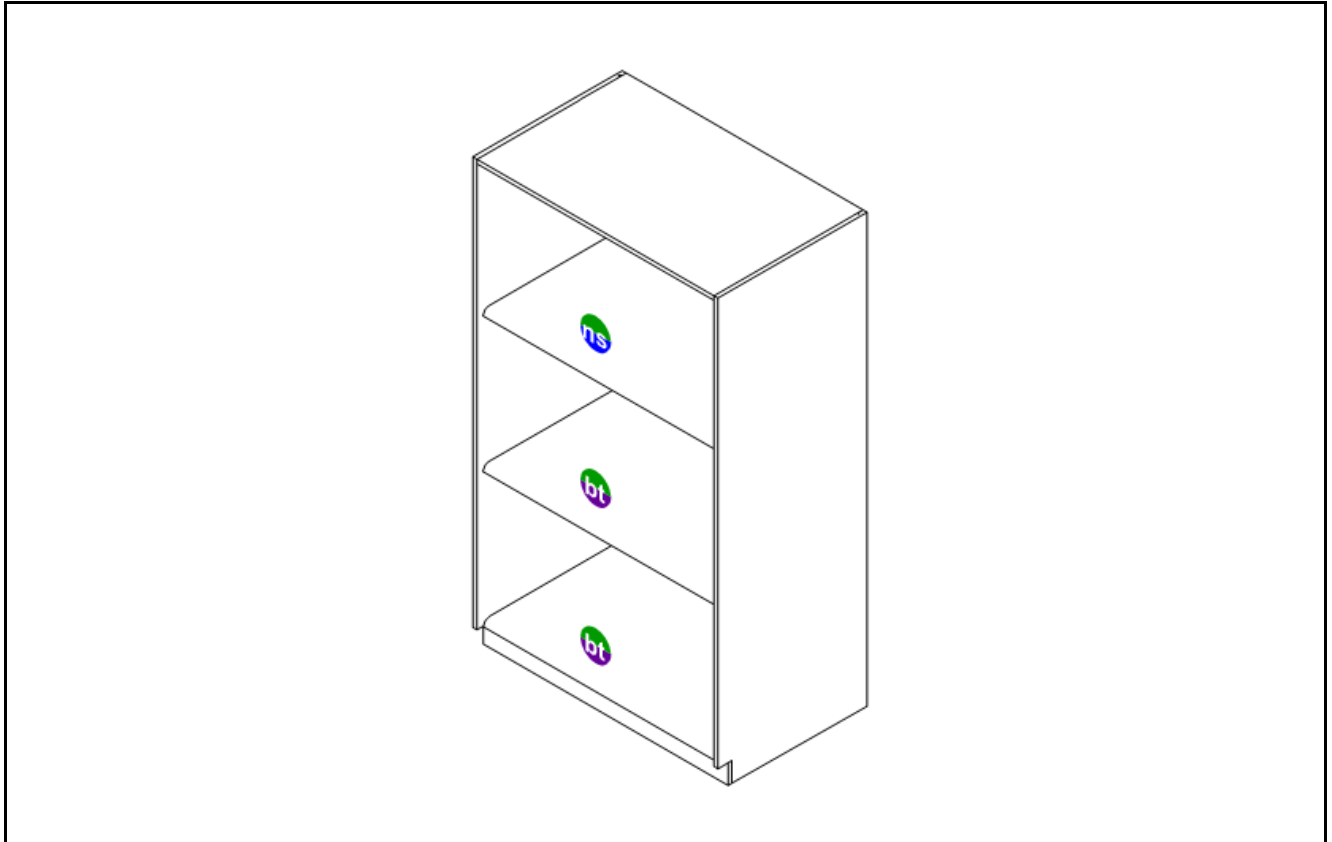

Tag: A8-2

Description: Instrument Cabinet

Manufacturer: Wenger

Manufacturer's Description: UltraStor 12 w/ Straight Grille Doors

Finish: Wenger Maple

Quantity: 1

Instruments: 1 Baritone Saxophone, 2 Bass Trombones

FF&E SPECIFICATIONS
Bartlett High School Band Room
5688 Woodlawn St.
Bartlett, TN 38134

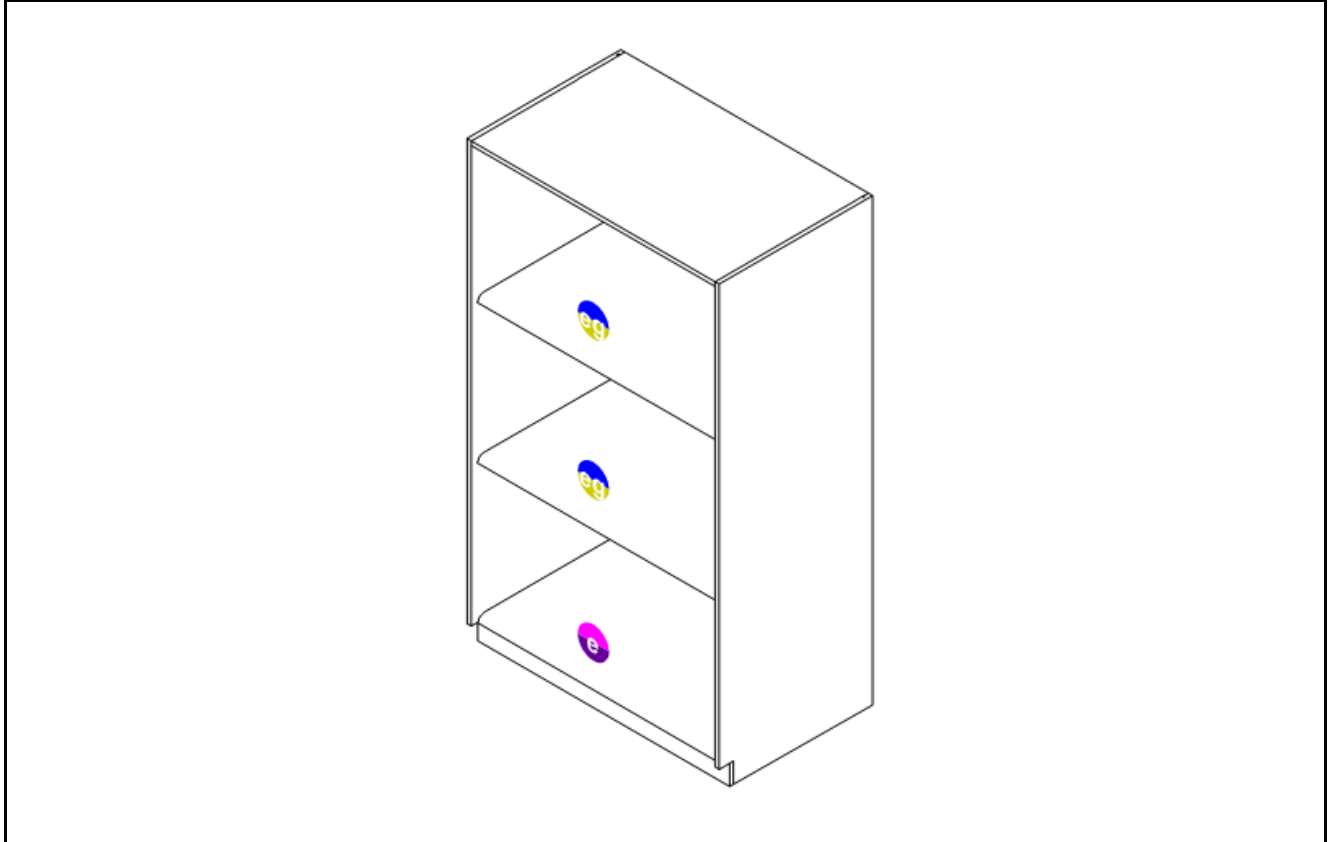

Tag: A8-3

Description: Instrument Cabinet

Manufacturer: Wenger

Manufacturer's Description: UltraStor 12 w/ Straight Grille Doors

Finish: Wenger Maple

Quantity: 1

Instruments: 2 Electric Guitars, 1 Euphonium



FF&E SPECIFICATIONS
Bartlett High School Band Room
5688 Woodlawn St.
Bartlett, TN 38134

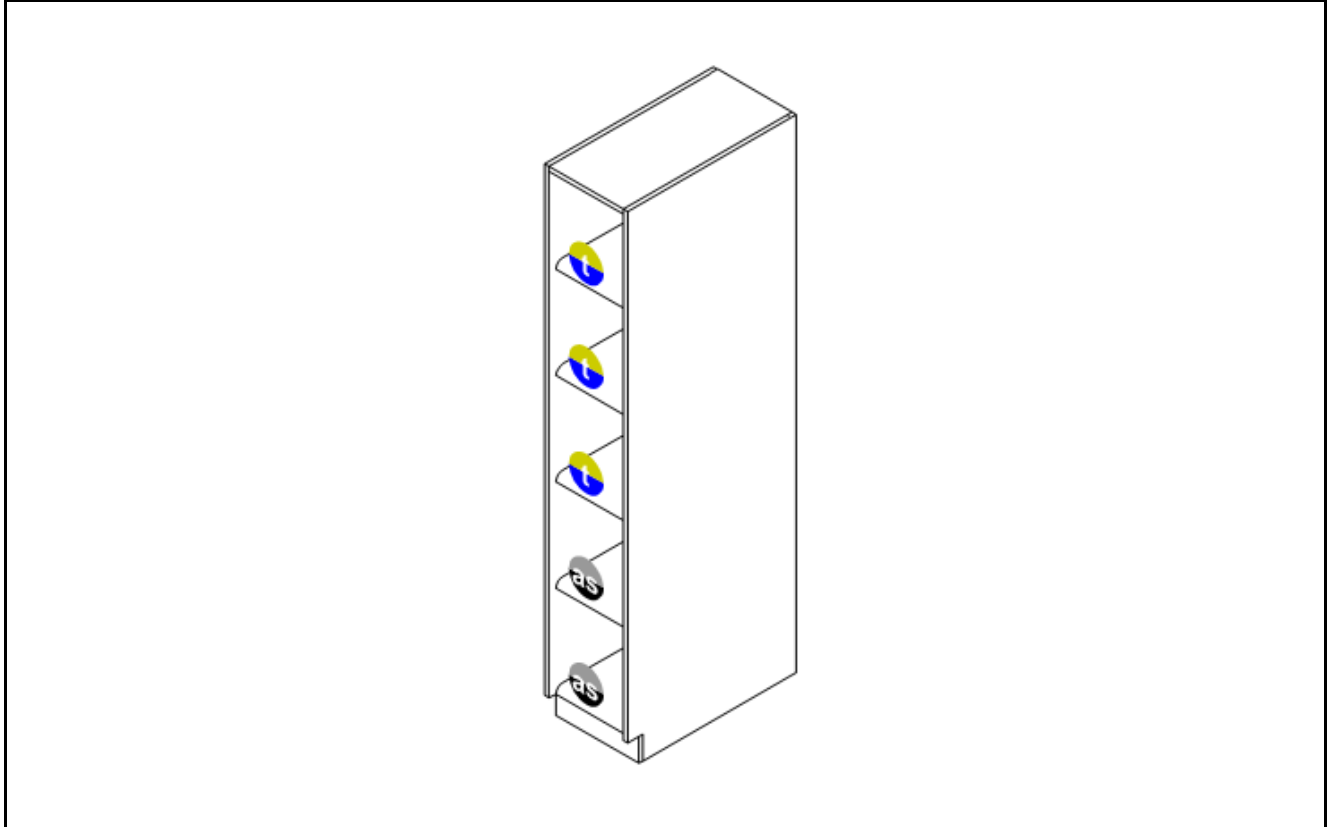

Tag: A9

Description: Instrument Cabinet

Manufacturer: Wenger

Manufacturer's Description: UltraStor 13 w/ Straight Grille Doors

Finish: Wenger Maple

Quantity: 1

Instruments: 3 Trumpets, 2 Alto Saxophones

FF&E SPECIFICATIONS
Bartlett High School Band Room
5688 Woodlawn St.
Bartlett, TN 38134

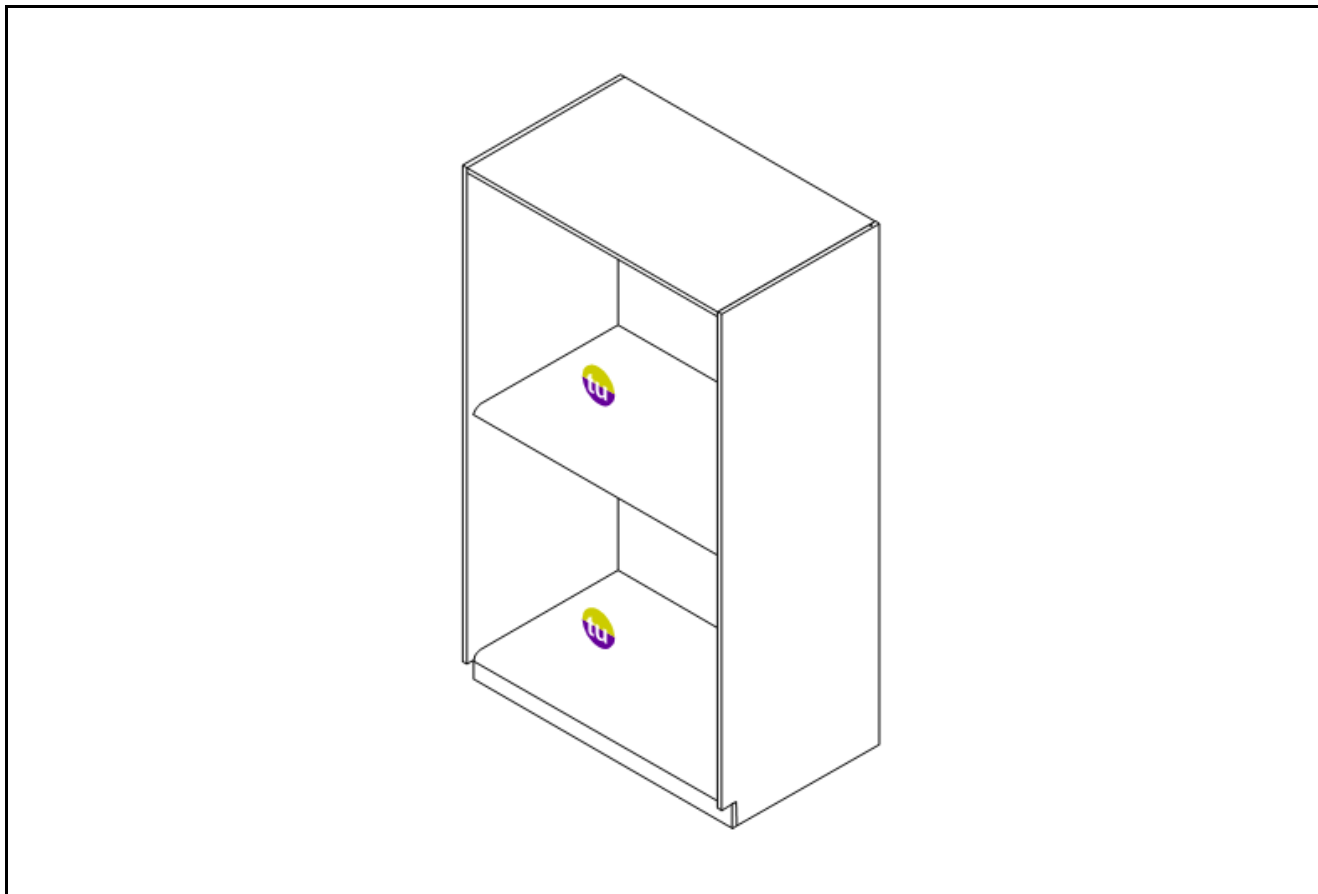

Tag: A10

Description: Instrument Cabinet

Manufacturer: Wenger

Manufacturer's Description: UltraStor 15 w/ Straight Grille Doors

Finish: Wenger Maple

Quantity: 6

Instruments: 2 Tubas (Upright Bell)



FF&E SPECIFICATIONS

Bartlett High School Band Room

5688 Woodlawn St.

Bartlett, TN 38134



Tag: B1

Description: Musician Chair

Manufacturer: Wenger

Manufacturer's Description: Student Chair

Finish: Black Plastic w/ Chrome Legs

Quantity: 100



FF&E SPECIFICATIONS
Bartlett High School Band Room
5688 Woodlawn St.
Bartlett, TN 38134



Tag: C1

Description: Music Stand

Manufacturer: Manhasset

Manufacturer's Description: Symphony Stand

Finish: Black

Quantity: 100



FF&E SPECIFICATIONS
Bartlett High School Band Room
5688 Woodlawn St.
Bartlett, TN 38134



Tag: D1

Description: Conductor's Mobile Station

Manufacturer: Wenger

Manufacturer's Description: Rehearsal Resource Center (L-Shaped)

Finish: Wenger Maple

Quantity: 1



FF&E SPECIFICATIONS
Bartlett High School Band Room
5688 Woodlawn St.
Bartlett, TN 38134



Tag: E1

Description: Uniform Storage Rack

Manufacturer: Wenger

Manufacturer's Description: GearBoss Shelving w/ Garment Bars

Quantity: See Furniture Plan



FF&E SPECIFICATIONS
Bartlett High School Band Room
5688 Woodlawn St.
Bartlett, TN 38134



Tag: F1-1

Description: Acoustical Panel

Manufacturer: Wenger

Manufacturer's Description: 4'x4' Wall Absorber Panel

Thickness: 3"

Fabric: TBD (allow for 2 colors)

Quantity: 32

Note: Layout of acoustical panels to be determined by Architect



FF&E SPECIFICATIONS
Bartlett High School Band Room
5688 Woodlawn St.
Bartlett, TN 38134



Tag: F1-2

Description: Acoustical Panel

Manufacturer: Wenger

Manufacturer's Description: 4'x6' Wall Absorber Panel

Thickness: 3"

Fabric: TBD (allow for 2 colors)

Quantity: 11

Note: Layout of acoustical panels to be determined by Architect



FF&E SPECIFICATIONS
Bartlett High School Band Room
5688 Woodlawn St.
Bartlett, TN 38134



Tag: F1-3

Description: Acoustical Panel

Manufacturer: Wenger

Manufacturer's Description: 4'x6' Type II Convex Wall Diffuser Panel

Thickness: 3"

Fabric: TBD (allow for 2 colors)

Quantity: 11

Note: Layout of acoustical panels to be determined by Architect



FF&E SPECIFICATIONS
Bartlett High School Band Room
5688 Woodlawn St.
Bartlett, TN 38134



Tag: F1-4

Description: Acoustical Panel

Manufacturer: Wenger

Manufacturer's Description: 4'x8' Wall Absorber Panel

Thickness: 3"

Fabric: TBD

Quantity: 1

Note: Layout of acoustical panels to be determined by Architect



FF&E SPECIFICATIONS
Bartlett High School Band Room
5688 Woodlawn St.
Bartlett, TN 38134



Tag: F1-5

Description: Acoustical Panel

Manufacturer: Wenger

Manufacturer's Description: 4'x4' Convex Ceiling Diffuser Panel

Thickness: 3"

Fabric: TBD

Quantity: 22

Note: Layout of acoustical panels to be determined by Architect